

# Contents

<b>1 Instructions</b>	<b>4</b>
1.1 General safety instructions	4
1.2 Appliance purpose	10
1.3 Manufacturer's liability	10
1.4 This user manual	10
1.5 Identification plate	10
1.6 Disposal	11
1.7 How to read the user manual	12
1.8 To save energy	12
<b>2 Description</b>	<b>13</b>
2.1 General Description	13
2.2 Control panel	14
2.3 Microwaves	15
2.4 Other parts	15
2.5 Available accessories	16
<b>3 Use</b>	<b>17</b>
3.1 Materials suitable for microwaves	17
3.2 First use	19
3.3 Using the accessories	19
3.4 Using the oven	20
3.5 Special functions	33
3.6 Automatic programs	38
3.7 Secondary menu	41
<b>4 Cleaning and maintenance</b>	<b>44</b>
4.1 Cleaning the surfaces	44
4.2 Cleaning the door glazing	45
4.3 Cleaning the oven	45
4.4 Vapor Clean	47
<b>5 Installation</b>	<b>50</b>
5.1 Electrical connection	50
5.2 Positioning	51

## TRANSLATION OF THE ORIGINAL INSTRUCTIONS

We advise you to read this manual carefully, which contains all the instructions for maintaining the appliance's aesthetic and functional qualities.

For further information on the product: [www.witt-ltd.com](http://www.witt-ltd.com)



## 1 Instructions

### IMPORTANT SAFETY INSTRUCTIONS

#### PLEASE READ CAREFULLY AND RETAIN FOR FUTURE REFERENCE

### 1.1 General safety instructions

#### Risk of personal injury

- **WARNING:** If the door or the door seal is damaged, the appliance must not be used until it has been repaired by a qualified person.
- **WARNING:** It is hazardous for anyone other than a competent person to carry out any service or repair operation which involves the removal of a cover which offers protection against exposure to microwave energy.
- **WARNING:** Liquids and other foods must not be heated in sealed containers since they are liable to explode.
- **WARNING:** During use the appliance and its accessible parts become very hot. Never touch the heating elements during use.
- During use the appliance and its accessible parts become very hot. Keep children at a safe distance.
- Never touch the heating elements during use.
- Wear oven gloves to protect your hands when handling food inside the oven.
- Never try to put out a fire or flames with water: Turn off the appliance and smother the flames with a fire blanket or other appropriate cover.
- This appliance may be used by children aged at least 8 and by people of reduced physical and mental capacity, or lacking in experience in the use of electrical appliances, provided that they are supervised or instructed by adults who are responsible for their safety.



- Children must never play with the appliance.
- Keep children under eight years of age at a safe distance if they are not constantly supervised.
- Do not allow children younger than 8 years old to come near the appliance when in operation.
- The appliance must never be cleaned by unsupervised children.
- The cooking process must always be monitored. Short cooking processes must be monitored continuously.
- Never leave the appliance unattended during cooking in which fat or oil could be released that could overheat and catch fire. Be very careful.
- Do not pour water directly onto very hot trays.
- Keep the oven door closed during cooking.
- Do not insert pointed metal objects (cutlery or utensils) into the slots in the appliance.
- If you need to move food or at the end of cooking, open the door 5 cm for a few seconds, let the steam come out, then open it fully.
- Switch off the appliance immediately after use.
- **DO NOT USE OR STORE FLAMMABLE MATERIALS NEAR THE APPLIANCE.**
- **DO NOT USE AEROSOLS IN THE VICINITY OF THIS APPLIANCE WHILST IT IS IN USE.**
- **DO NOT MODIFY THE APPLIANCE.**
- Have qualified personnel carry out installation and assistance interventions according to the standards in force.
- Do not try to repair the appliance yourself or without the intervention of a qualified technician.
- Do not pull the cable to remove the plug.



## Instructions

### Using microwaves

- Check the appliance visually during the cooking of foods in plastic or paper containers.



Improper use

**Danger of explosion**



- When using the microwave to heat or reheat liquids, the boiling process may be delayed – boiling temperature can be reached without the formation of the usual “rolling boil”. This delayed boiling and consequent superheating of the liquid can generate an explosion inside the appliance, or sudden boiling over of the superheated liquid can occur when removing the container from the appliance. To avoid these dangers, it is necessary to insert the supplied boiling rod (or a heat-resistant plastic spoon) in the container while heating.

- Use the microwave only for the preparation of food for consumption. Other types of applications are strictly forbidden (e.g. drying clothes, warming slippers, sponges, wet cloths or the like, dehydrating foods) because they can lead to the risk of injury or fire.
- Clean the appliance constantly and remove any food residue.
- Do not use the microwave to dry food.
- Do not use the microwave to heat oils or fry.
- Do not use the appliance to heat foods or beverages containing alcohol.
- Do not heat eggs in their shells or whole hard boiled eggs; they may explode even after the heating process has completed.
- Do not heat food contained in food packages.



- Baby food should not be heated in sealed containers. Remove the cover or the teat (in the case of baby bottles). Always check the temperature of the preparation after it has been heated, it should not be too high. For an even temperature and to avoid scalding stir or shake the contents.
- Puncture the skin of food that has a hard skin or peel (e.g. potatoes, apples, etc.) before cooking.
- Do not use the microwave functions when the oven is empty.
- Use kitchenware and utensils that are suitable for use in a microwave oven.
- Do not use aluminium containers to cook food.
- Do not use dishes with metallic decorations (gold-plated or silver).
- This appliance complies with the current standards and directives regarding safety and electromagnetic compatibility. However, it is recommended that people who wear pacemakers maintain a minimum distance of 20-30 cm between the pacemaker and the microwave oven when it is in operation. Contact the pacemaker manufacturer for further information.
- The appliance operates in the 2.4GHz ISM band.
- In compliance with the provisions regarding electromagnetic compatibility, the appliance belongs to group 2 and class B (EN 55011).

## **Risk of damaging the appliance**

- Do not use abrasive or corrosive detergents (e.g. scouring powders, stain removers and metallic sponges) on glass parts. Use wooden or plastic utensils.



## Instructions

- Do not use rough or abrasive materials or sharp metal scrapers.
- Do not sit on the appliance.
- Do not use cleaning products containing chlorine, ammonia or bleach on parts made of steel or that have metallic surface finishes (e.g. anodizing, nickel- or chromium-plating).
- Racks and trays should be inserted as far as they will go into the side guides. The mechanical safety locks that prevent them from being removed must face downwards and towards the back of the oven cavity.

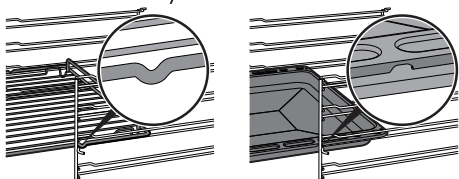

- Do not use steam jets to clean the appliance.
- Do not spray any spray products near the appliance.

- (on some models only) Before starting the pyrolytic cycle, remove any food residues or large spills from previous cooking operations from the inside of the oven.
- Do not obstruct ventilation openings and heat dispersal slots.
- Fire hazard: never leave objects in the oven cavity.
- **DO NOT FOR ANY REASON USE THE APPLIANCE AS A SPACE HEATER.**
- Do not use plastic cookware or containers when cooking food.
- Do not put sealed tins or containers in the oven.
- Remove all trays and racks which are not required during cooking.
- Do not cover the bottom of the oven cavity with aluminium or tin foil sheets.
- Do not place pans or trays directly on the bottom of the oven cavity.



- If you wish to use greaseproof paper, place it so that it will not interfere with the hot air circulation inside the oven.
- Do not use the open door to rest pans or trays on the internal glass pane.
- Never use the oven door to lever the appliance into place when fitting.
- Avoid exerting too much pressure on the oven door when open.
- Do not use the handle to lift or move the appliance.
- Do not install / use the appliance outdoors.
- To avoid potential overheating, the appliance must not be installed behind a decorative door or a panel.
- Installation and servicing should be carried out by qualified personnel in accordance with current standards.
- Have the electrical connection performed by authorised technical personnel.
- The appliance must be connected to earth in compliance with electrical system safety standards.

## Installation and maintenance

- THIS APPLIANCE **MUST NOT BE INSTALLED** IN BOATS OR CARAVANS.
- The appliance must not be installed on a pedestal.
- Position the appliance into the cabinet cut-out with the help of a second person.
- Use cables that can withstand temperatures of at least 90°C.
- The tightening torque of the screws of the terminal supply wires must be 1.5 - 2 Nm.
- If the power cable becomes damaged, contact technical support immediately to arrange for it to be replaced in order to avoid possible hazards.



## Instructions

- Always use any necessary/required personal protective equipment (PPE) before performing any work on the appliance (installation, maintenance, positioning or movement).
- Before performing any work on the appliance, switch off the power supply.
- This appliance can be used up to a maximum altitude of 2000 metres above sea level.

### 1.2 Appliance purpose

This appliance is intended for cooking food in the home environment. Every other use is considered improper. It must also not be used:

- In kitchen areas provided for employees in shops, offices and other work environments
- On farms/farm accommodation
- By guests in hotels, motels and other types of residential environments
- In bed and breakfast accommodation.

### 1.3 Manufacturer's liability

The manufacturer declines all liability for damage to persons or property caused by:

- Use of the appliance other than that specified
- Failure to comply with the instructions in the user manual
- Tampering with any part of the appliance
- The use of non-original spare parts.

### 1.4 This user manual

- This user manual is an integral part of the appliance and must therefore be kept in its entirety and within the user's reach for the whole working life of the appliance.
- Read this user manual carefully before using the appliance.
- The explanations in this manual include images, which describe all that regularly appears on the display. However, it should be kept in mind that the appliance may be equipped with an updated version of the system, and as such, all that appears on the display may differ from those in the manual.

### 1.5 Identification plate

The identification plate bears the technical data, serial number and brand name of the appliance. Do not remove the identification plate for any reason.





## 1.6 Disposal



This appliance conforms to the WEEE European directive (2012/19/EU) and must be disposed of separately from other waste at the end of its service life.

The appliance does not contain substances in quantities sufficient to be considered hazardous to health and the environment, in accordance with current European directives.

To dispose of the appliance:

- Cut the power cable and remove it.



**Power voltage**

**Danger of electrocution**

- Disconnect the mains power supply.
- Unplug the appliance.
- Deliver the appliance to the appropriate recycling centre for electrical and electronic equipment waste, or return it to the retailer when purchasing an equivalent product, on a one for one basis.

Our appliances are packaged in non-polluting and recyclable materials.

- Deliver the packing materials to the appropriate recycling centre.



**Plastic packaging**

**Danger of suffocation**

- Do not leave the packaging or any part of it unattended.
- Do not let children play with the plastic bags.



# Instructions

## 1.7 How to read the user manual

This user manual uses the following reading conventions:



### Instructions

General information on this user manual, on safety and final disposal.



### Description

Description of the appliance and its accessories.



### Use

Information on the use of the appliance and its accessories, cooking advice.



### Cleaning and maintenance

Information for proper cleaning and maintenance of the appliance.



### Installation

Information for the qualified technician: Installation, operation and inspection.

## 1.8 To save energy

- Only preheat the appliance if the recipe requires you to do so.
- Unless otherwise indicated on the package, defrost frozen foods before placing them in the oven.
- When cooking several types of food it is recommended to cook the foods one after the other to make the best use of the already hot oven.
- Use dark metal moulds: They help to absorb the heat better.
- Remove all trays and racks which are not required during cooking.
- Stop cooking a few minutes before the time normally used. Cooking will continue for the remaining minutes with the heat which has accumulated inside the oven.
- Reduce any opening of the door to a minimum to avoid heat dispersal.
- Keep the inside of the oven clean at all times.



Safety instructions



Information / Advice



## 2 Description

### 2.1 General Description

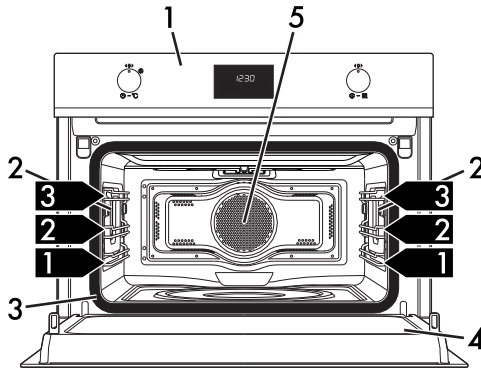

1 Control panel

2 Oven light

3 Seal

4 Door

5 Fan

**1,2,3** Frame shelf



# Description

## 2.2 Control panel

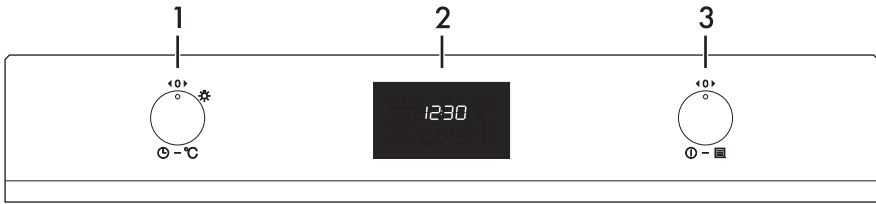

### 1 Temperature knob — °C

This knob is used to select:

- Microwave power level
- Cooking temperature
- Function duration
- Programmed cooking procedures
- Current time
- Switching on or off of the appliance internal light.

### 2 Display

Displays the current time, the selected cooking function, power and temperature and any time set.

### 3 Function knob —

This knob can be used to:

- Turn the appliance on and off
- Select a function
- Temporarily start or stop a function.



## 2.3 Microwaves

The appliance is equipped with a microwave generator called a magnetron. The microwaves generated are evenly emitted into the oven cavity in order to reach the food and heat it.

Heating takes place through the process of friction between the molecules contained within the food (mainly water molecules), with the consequent generation of heat.

The heat generated directly inside the food allows defrosting, re-heating or cooking in a shorter length of time compared to traditional cooking.

The use of suitable containers for microwave cooking allows the microwaves to reach the food in a uniform manner (see 3.1 Materials suitable for microwaves).

## 2.4 Other parts

### Shelves

The appliance features shelves to position trays and racks at different heights. The insertion heights are indicated from the bottom upwards (see 2.1 General Description).

## Cooling fan

The fan cools the appliance and comes into operation during cooking.

The fan causes a steady outflow of air from above the door which may continue for a brief period of time even after the appliance has been turned off.

## Interior lighting

The appliance's interior lighting comes on:

- When the door is opened.
- When any function is started, apart from

the ECO  and Vapor Clean  functions.

- When the temperature knob is turned briefly to the right (manual activation and deactivation).



When the door is open, it is not possible to turn the internal lighting off.



## Description

### 2.5 Available accessories

#### Boiling rod



To be placed in containers when heating liquids, necessary to avoid delayed boiling.

#### Rack

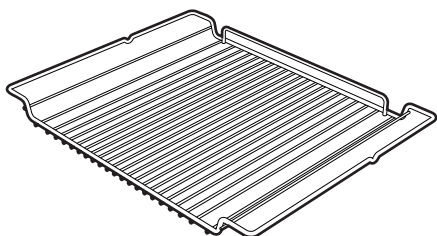

Used for supporting containers with food during cooking.

#### Glass dish

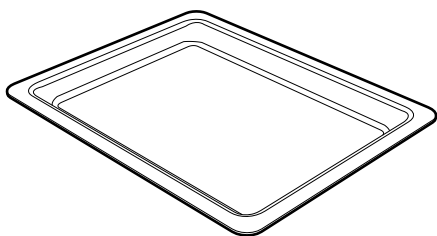

Used for any type of cooking and collecting fat from foods placed on the rack above.

#### Tray rack

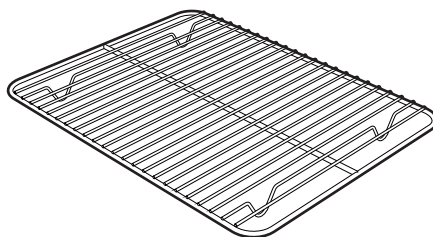

To be placed over the top of the oven tray; for cooking foods which may drip.

**i** Some models are not provided with all accessories.

**i** The oven accessories intended to come into contact with food are made of materials that comply with the provisions of current legislation.

**i** Original supplied and optional accessories can be requested to Authorised Assistance Centres. Use only original accessories supplied by the manufacturer.



## 3 Use

### Instructions



**High temperature inside the oven during use**  
**Danger of burns**

- Keep the oven door closed during cooking.
- Protect your hands wearing heat resistant gloves when moving food inside the oven.
- Do not touch the heating elements inside the oven.
- Do not pour water directly onto very hot trays.
- Do not allow children to approach the appliance when it is in operation.



**Improper use**  
**Risk of damage to enamelled surfaces**

- Do not cover the bottom of the oven cavity with aluminium or tin foil sheets.
- If you wish to use greaseproof paper, place it so that it will not interfere with the hot air circulation inside the oven.
- Do not bang or drag kitchenware over the glazed bottom of the oven cavity.
- Do not pour water directly onto very hot trays.



**High temperature inside the oven during use**  
**Danger of fire or explosion**

- Do not spray any spray products near the appliance.
- Do not use or leave flammable materials near the appliance.
- Do not use plastic kitchenware for cooking food (except with the microwave function).
- Do not put sealed tins or containers in the oven.
- Never leave the appliance unattended during cooking operations where fats or oils could be released.
- Remove all trays and racks which are not required during cooking.

### 3.1 Materials suitable for microwaves

In general, in order for all of the food to be reached, the materials used for microwave cooking must be transparent to microwave energy.

Below is a table of materials to use and those not to use:



## Use

### MATERIALS TO USE:

#### - Glass (always remove covers) \*

- Baking ware
- Glasses
- Jars

#### - Porcelain

#### - Earthenware

#### - Plastic (only where suitable for microwave use) \*

- Containers
- Plastic wrap (must not come into contact with the food)

\* only if heat-resistant.

### MATERIALS NOT TO BE USED

#### - Metals (these can lead to arcing or sparks)

- Aluminium foil
- Aluminium trays
- Plates
- Metal utensils
- Freezer bags tie wraps

#### - Wood

#### - Crystal glasses

#### - Paper (risk of fire)

#### - Polystyrene containers (danger of food contamination)



Dishes must be free of metal decorations.



Do not use metal accessory trays in the microwave or combined microwave functions.

### Testing dishes



The microwave function can be used without any food inside the oven only for this test.

To check whether or not kitchenware is suitable for use with microwave cooking carry out this simple test:

1. Remove all accessories from the oven cavity.
2. Place the kitchenware to be tested on the rack inserted in the first runner.
3. Select the maximum power level (e.g. 1000W).
4. Set a cooking time of 30 seconds.
5. Start cooking.



#### Unsuitable kitchenware Risk of damage to the appliance

- If there is crackling or if sparks are emitted from the kitchenware then immediately terminate the test. In this instance the kitchenware is not suitable for microwave cooking.
6. At the end of the test the kitchenware must be either cold or slightly warm. If the kitchenware is hot then it should be considered as unsuitable for microwave use.





### 3.2 First use

1. Remove any protective film from the outside or inside of the appliance, including accessories.
2. Remove any labels (apart from the technical data plate) from the accessories and from the oven cavity.
3. Remove and wash all the appliance accessories (see 4 Cleaning and maintenance).
4. Heat the empty oven at maximum temperature (using the traditional functions) so as to remove any manufacturing residues.



For the first reheating use a traditional function and not a microwave function.

### 3.3 Using the accessories

#### Tray rack

The tray rack has to be inserted into the tray. In this way fat can be collected separately from the food which is being cooked.

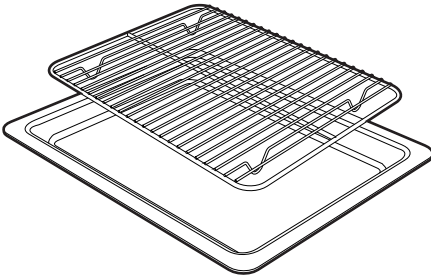

#### Racks and trays

Racks and trays have to be inserted into the side guides until they come to a complete stop.

- The mechanical safety locks that prevent the rack from being removed accidentally must face downwards towards the back of the oven.

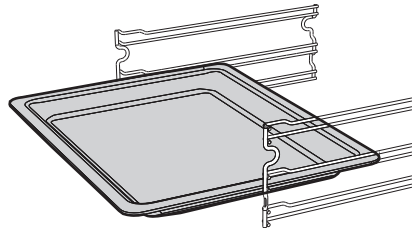
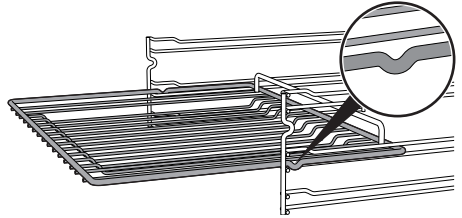

**High temperature  
Danger of burns**

- The accessory gets very hot. Always use oven gloves when handling.



Gently insert racks and trays into the oven until they come to a stop.



Clean the trays before using them for the first time to remove any residues left by the manufacturing process.



# Use

## Boiling rod









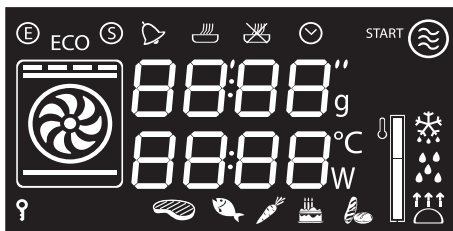

When using the microwave to heat or reheat liquids, the boiling process may be delayed while the liquids nevertheless exceed 100 degrees. To avoid this, place the boiling rod (or a heat-resistant plastic spoon) supplied into the container while heating.



## 3.4 Using the oven

### Display



-  Eco Logic indicator light
-  Showroom indicator light
-  Minute minder timer indicator light
-  Timed cooking indicator light
-  Programmed cooking indicator light
-  Clock indicator light
-  Microwave indicator light
-  Defrost light
-  Child lock indicator light
-  Temperature level reached



### Improper use Danger of explosion/burns

- To avoid the danger of explosion inside the appliance or the sudden boiling over of superheated liquids, it is always necessary to immerse the boiling rod in the liquid being heated.



### High temperature Risk of damage to the accessory

- Use the boiling rod only with Microwave functions. The rod must not be used with combination and traditional functions.



## Operating modes

**Stand-by:** When no function is selected, the display shows the current time.



**ON:** When any function starts the display shows the current settings such as temperature, duration, microwave power level and the temperature level reached.

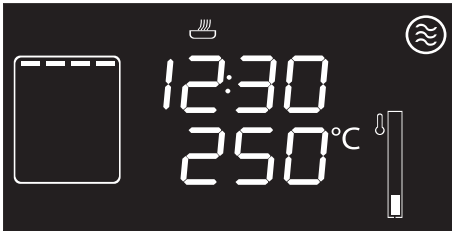

Each time the temperature knob is pressed during the operation of a function the parameters will be cycled through in the following order.

For each parameter the setting can be altered by turning the temperature knob to the right or left. Keep the knob turned to produce a faster increase or decrease.

**If a microwave function is selected:**



1. Microwave power level.
2. Function duration.

**If a Microwave+Grill function is selected:**



1. Temperature.
2. Function duration.
3. Microwave power level.

**If a Grill function is selected:**



1. Temperature
2. Minute minder timer duration.
3. Function duration.
4. Programmed cooking duration (if timed cooking has been selected).
5. Time display.



## Use

### Setting the time

On the first use, or after a power failure, **00:00** will be flashing on the appliance's display. To be able to start any cooking function, the current time must be set.

1. Turn the temperature knob to set the hour displayed (to increase or a decrease more quickly keep the knob turned to the right or left).
2. Press the temperature knob.
3. Turn the temperature knob to set the minutes displayed (to increase or a decrease more quickly keep the knob turned to the right or left).
4. To confirm the settings press the temperature knob.



It may become necessary to change the current time, for example for daylight saving time. From stand-by mode keep the temperature knob turned to the right or left until the hour value flashes.

It is not possible to change the time if the appliance is **ON**.

### Microwaves



**Improper use**

**Risk of damage to the appliance**

When using the microwave functions, food must be placed in a suitable container on the rack inserted in the first runner.

**DO NOT USE CONTAINERS/ ACCESSORIES (trays, glass dishes, etc.) PLACED DIRECTLY ON THE FLOOR OF THE OVEN.**

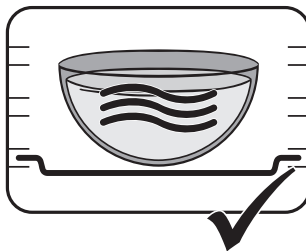
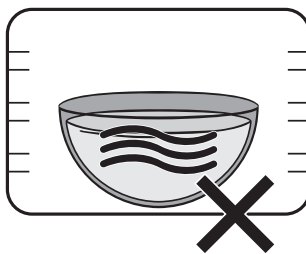

For perfect results with long microwave and combination cooking functions, food should be stirred once or twice during cooking.



## Microwaves

Given that they penetrate directly into the food, microwaves allow cooking to take place in a very short period of time and with a considerable saving of energy. They are suitable for cooking without fat and also for defrosting and re-heating food while maintaining its original appearance and fragrance.

1. Select the microwave function  using the function knob.

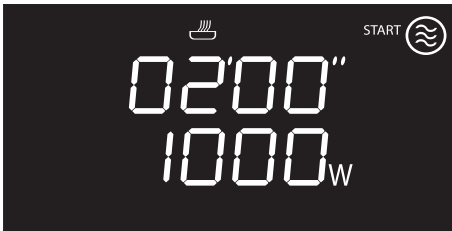

2. Press the temperature knob.
3. Turn the temperature knob to change the cooking time (max 30 minutes).
4. Press the temperature knob.
5. Turn the temperature knob to change the power level from 100W to 1000W (see Microwave power levels).

6. Press the function knob to start microwave cooking.



If the door is opened then cooking will stop. Once the door is closed press the function knob to resume cooking.



Press the function knob to temporarily stop the cooking function. Press it again to resume cooking.

7. When cooking has completed the word **STOP** appears on the display and a buzzer sounds.





## Use

8. To deactivate the buzzer, press or rotate one of the two knobs or open the door.



To deactivate the buzzer and select an additional timed cooking period, turn the temperature knob to the right.



To deactivate the buzzer and select a different cooking function, turn the function knob to the right or left.



To turn off the appliance press and hold the function knob.

### Microwave power levels

Below is a list of the power levels that can be selected:

Power (W)	Useful for
100	Defrosting food
200	
300	
400	Cooking meat or delicate cooking
500	
600	Re-heating and cooking food
700	
800	
900	Heating liquids
1000	

### QUICK START microwave function



The QUICK START function allows the microwave to be started quickly. This is useful for heating small quantities of liquid or food.

1. From stand-by mode press the function knob twice.

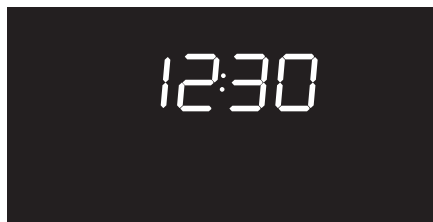

2. The appliance will start the microwave oven with the default settings.

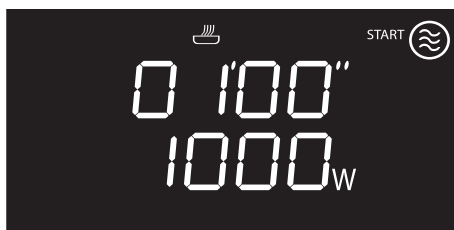



## Combination functions



### Improper use Risk of damage to the appliance

- Do not use the combination functions to heat or boil liquids.



Combination cooking is a mix of traditional cooking and microwave operation. These functions are indicated by the switching on of a traditional function symbol together with the microwave function indicator light .

- Use the function knob to select a "combination" function.

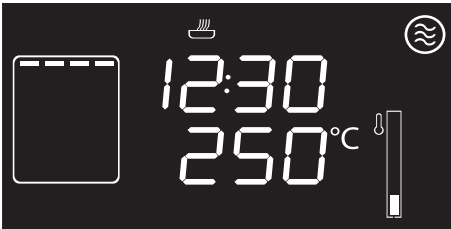

- Press the temperature knob.
- Turn the knob to set the temperature.
- Press the temperature knob.
- Turn the temperature knob to change the cooking time.
- Press the temperature knob.
- Turn the temperature knob to change the power level (from 100W to 700W).
- Press the function knob to start combination cooking.

## Pre-heating stage

Cooking itself is preceded by a preheating stage, which allows the appliance to heat to the cooking temperature more quickly.

This stage is indicated by the flashing of the temperature level reached indicator.



At the end of the preheating stage the temperature level reached indicator remains on and a buzzer sounds to indicate that food can be placed into the oven.



With the combination Microwave+Grill function, preheating is not performed given the type of cooking and in order to cook more quickly.



Cooking can be stopped at any time by pressing and holding the function knob for at least 3 seconds.



# Use

## Combination functions list



### Microwave + Grill

The use of the grill results in perfect browning of the food's surface.



Using the microwave on the other hand leads to rapid internal cooking of the food.



### Microwave + static + fan

The operation of the fan, combined with traditional cooking, ensures consistent cooking even with complex recipes. Using the microwave on the other hand leads to rapid internal cooking of the food.



### Microwave + Circulaire + Fan

For combination cooking of food in a short time thanks to the microwave action working together with hot air circulation.



## Traditional functions

1. Select a cooking function with the function knob.

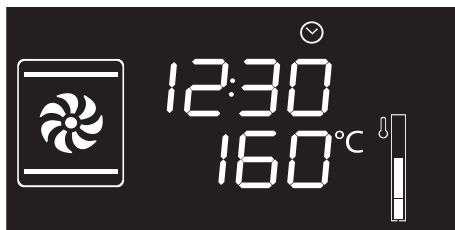

2. Press and turn the temperature knob to modify the cooking temperature.
3. Press the function knob to start the traditional cooking function.



A function can be interrupted at any time by pressing and holding the function knob for at least 3 seconds.

## Pre-heating stage

Cooking itself is preceded by a preheating stage, which allows the appliance to heat to the cooking temperature more quickly.

This stage is indicated by the flashing of the temperature level reached indicator.



At the end of the preheating stage the temperature level reached indicator remains on and a buzzer sounds to indicate that food can be placed into the oven.







## Traditional functions list



### ECO

This function is particularly suitable for cooking on a single shelf with low energy consumption.

Ideal for cooking meat, fish and vegetables. It is not recommended for leavened foods.

To obtain maximum energy savings and reduce cooking times, it is recommended to place food in the oven without preheating.



When using the ECO function, avoid opening the door during cooking.



Cooking (and preheating) times are longer with the ECO function.



### Static

As the heat comes from above and below at the same time, this system is particularly suitable for certain types of food. Traditional cooking, also known as static cooking, is suitable for cooking just one dish at a time. Perfect for all types of roasts, bread and cakes, and in any case, particularly suitable for fatty meats such as goose and duck.



### Grill

The heat coming from the grill element gives perfect grilling results above all for thin and medium thickness meat and, in combination with the rotisserie (where fitted), gives the food an even browning at the end of cooking. Perfect for sausages, spare ribs and bacon. This function enables large quantities of food, particularly meat, to be grilled evenly.



### Fan assisted

The operation of the fan, combined with traditional cooking, ensures consistent cooking even with complex recipes. Perfect for biscuits and cakes, even when simultaneously cooked on several levels. (For multiple-level cooking, we recommend using the 2<sup>nd</sup> and 4<sup>th</sup> shelves).



### Fan with grill

The air produced by the fan softens the strong heatwave generated by the grill, grilling perfectly even very thick foods. Perfect for large cuts of meat (e.g. shin of pork).



## Use



### Fan + lower element

The combination of the fan with just the lower heating element allows cooking to be completed more rapidly. This system is recommended for sterilising or for finishing off the cooking of foods which are already well-cooked on the surface, but not inside, which therefore need a little more heat. Perfect for any type of food.



### Circulaire

The combination of the fan and the circulaire heating element (incorporated in the rear of the oven) allows you to cook different foods on several shelves, as long as they need the same temperatures and the same type of cooking. Hot air circulation ensures instant and even distribution of heat. It will be possible, for instance, to cook fish, vegetables and biscuits simultaneously (on different levels) without odours and flavours mingling.



### Turbo

The combination of fan assisted cooking and traditional cooking allows different foods to be cooked on several levels extremely quickly and efficiently, without odours and flavours mingling. Perfect for large volumes that call for intense cooking.

## Minute minder timer





This function only activates the buzzer, without stopping cooking.

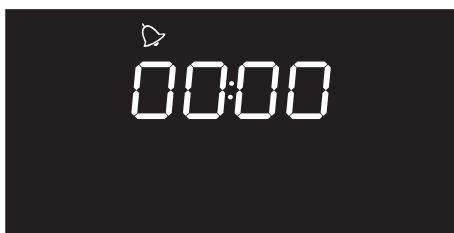

The minute minder can be activated both during cooking and when the appliance is in standby.

1. Press the temperature knob once (twice if cooking is already in progress). The display shows **00:00** and the  indicator light flashes.



2. Turn the knob to set the cooking time (from 1 minute up to 4 hours). After a few seconds, the  indicator light stops flashing and the countdown starts.
3. Select the required cooking function and wait for the buzzer to sound, indicating that the cooking time is over. The  indicator light flashes.



- To deactivate the buzzer, press or rotate one of the two knobs.
- To select an additional minute minder timer, turn the temperature knob.



You must set the value to zero to remove the minute minder timer.

### Timed cooking



Timed cooking is the function which allows a cooking operation to be started and then ended after a specific length of time set by the user.



Activation of timed cooking cancels any minute minder timer which may previously have been set.

- After selecting a cooking function and temperature, press the temperature knob three times. The display shows



and the  indicator light flashes.

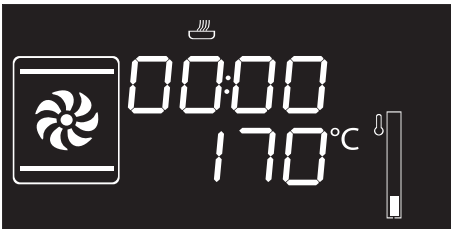

- Turn the temperature knob to the right or left to set the cooking time from 00:01 to 12:59. Keep the knob turned to produce a faster increase or decrease.

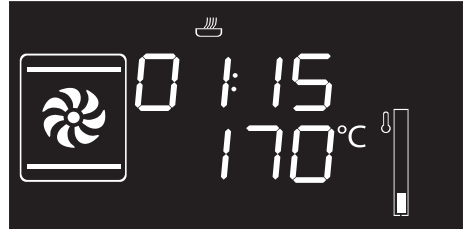

- A few seconds after the required duration has been set, the  indicator light stops flashing and timed cooking starts.



To extend the cooking time manually, press the temperature knob again. The appliance will resume its normal operation with the previously selected cooking settings.

- When cooking has completed the word **StoP** appears on the display and a buzzer sounds.





## Use

- To deactivate the buzzer, press or rotate one of the two knobs or open the door.



To deactivate the buzzer and select an additional timed cooking period, turn the temperature knob to the right.





To deactivate the buzzer and select a different cooking function, turn the function knob to the right or left.



To turn off the appliance press and hold the function knob.

### Modifying the data set during timed cooking

During operation, it is possible to modify timed cooking duration:

- When the  indicator light is steady and cooking is in progress inside the appliance, press the temperature knob twice. The  indicator light will start flashing.
- Turn the temperature knob right or left to alter the pre-set cooking time.

### Programmed cooking



Programmed cooking refers to the function that allows cooking to be stopped automatically at a time set by the user, after which the appliance will switch off automatically.

- After selecting a cooking function and temperature, press the temperature knob three times. The display shows



and the  indicator light flashes.

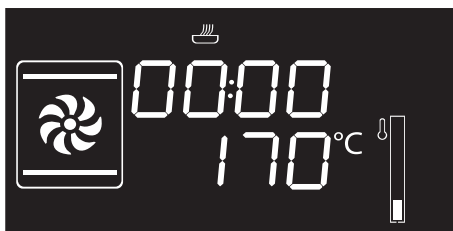

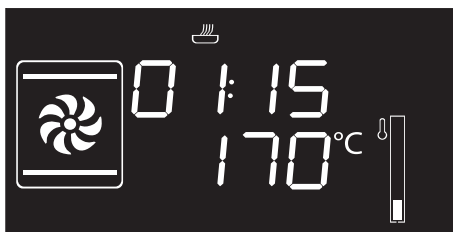

- Turn the knob to the right or left to set the cooking time from 00:01 to 12:59. Keep the knob turned to produce a faster increase or decrease.





3. Press the temperature knob a fourth time.

The  indicator light flashes. Turn the knob right or left to set the cooking end time.

4. After a few seconds, the  and  indicator lights stop flashing. The appliance waits for the set start time.

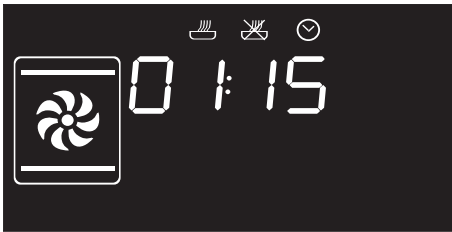

To extend the cooking time manually, press the temperature knob again. The appliance will resume its normal operation with the previously selected cooking settings.



With programmed cooking, the oven is switched on ten minutes beforehand to allow the appliance to reach cooking temperature (preheating).

5. When cooking has completed the word **Stop** appears on the display and a buzzer sounds.

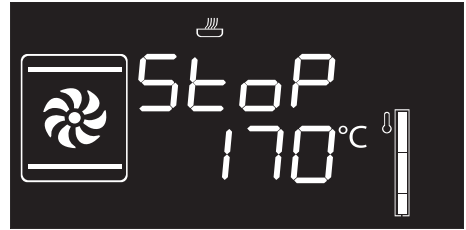

6. To deactivate the buzzer, press or rotate one of the two knobs or open the door.



To turn off the appliance press and hold the function knob.



For safety reasons, it is not possible to set the end of cooking time by itself without setting the cooking duration.

### Modifying the data set during programmed cooking









After modifying the cooking duration, the end of cooking time must be re-set.

During operation, it is possible to modify programmed cooking duration:



## Use

1. When the  and  indicator lights are lit steadily and the appliance is waiting for cooking to start, press the temperature knob twice. The  indicator light will start flashing.
2. Turn the temperature knob right or left to alter the pre-set cooking time.
3. Press the temperature knob again. The  indicator light switches off and the  indicator light starts flashing. The display shows the cooking end time.
4. Turn the temperature knob right or left to delay the cooking end time.
5. After a few seconds the  and  indicator lights stop flashing and programmed cooking resumes with the new settings.

### Traditional cooking tips

#### General advice

- Use a fan assisted function to achieve consistent cooking at several levels.
- It is not possible to shorten cooking times by increasing the temperature (the food could be overcooked on the outside and undercooked on the inside).

#### Advice for cooking meat

- Cooking times vary according to the thickness and quality of the food and to consumer taste.
- Use a meat thermometer when roasting meat, or simply press on the roast with a spoon. If it is hard, it is ready; If not, it needs another few minutes cooking.

#### Advice for cooking with the Grill and the Fan with grill

- Meat can be grilled even when it is put into the cold oven or into the preheated oven if you wish to change the effect of the cooking.
- With the Fan with grill function, we recommend that you preheat the oven before grilling.
- We recommend placing the food at the centre of the rack.



## Advice for cooking desserts/pastries and biscuits

- Use dark metal moulds: They help to absorb the heat better.
- The temperature and the cooking time depend on the quality and consistency of the dough.
- To check whether the dessert is cooked right through: At the end of the cooking time, put a toothpick into the highest point of the dessert. If the dough does not stick to the toothpick, the dessert is cooked.
- If the dessert collapses when it comes out of the oven, on the next occasion reduce the set temperature by about 10°C, selecting a longer cooking time if necessary.

## To save energy

- Stop cooking a few minutes before the time normally used. Cooking will continue for the remaining minutes with the heat which has accumulated inside the oven.
- Reduce any opening of the door to a minimum to avoid heat dispersal.
- Keep the inside of the appliance clean at all times.

## 3.5 Special functions

### Proving



When using the proving function the temperature cannot be altered.



For successful proving, a container of water should be placed in the bottom of the oven.

1. Place the dough to rise on the second level.
2. Press and turn the function knob to select the proving function  **START** flashes.
3. Press the function knob to start the proving function.
4. At the end, **StoP** will appear and the buzzer will sound.



## Use

- To deactivate the buzzer, press or rotate one of the two knobs or open the door.
- Press and hold the function knob for at least 3 seconds to exit the function.

### Reheat



This function is for microwave re-heating of food that has been previously cooked and stored in the refrigerator.

- Press the function knob to select the re-heating function.

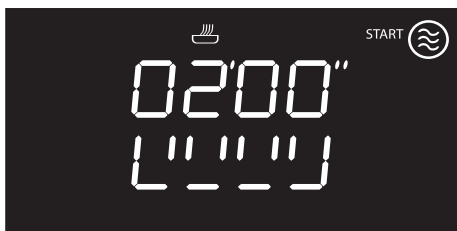

- Press the temperature knob.
- Turn the temperature knob to change the re-heating time.
- Press the function knob to confirm the settings and start re-heating.

### Sabbath



This function allows food to be cooked in accordance with the provisions of the Jewish religion day of rest.



This function results in the appliance operating in a particular way:

- Cooking can proceed indefinitely, it is not possible to set any time.
- No preheating will be performed.
- The cooking temperature which can be selected varies between 60-100 °C.
- Oven light disabled, any operation such as opening the door or manual activation with the knob will not activate the light.
- The internal fan remains turned off.
- Knob illumination and audible prompts remain disabled.





After activating the Sabbath function the settings cannot be altered.



Any action on the knobs will produce no effect; only the function knob remains active to allow the appliance to be turned off.

1. Press and turn the function knob to select the Sabbath function **SAbb**.
2. Press and turn the temperature knob to modify the temperature of the function.
3. Press the temperature knob to confirm the set temperature. **START** flashes.
4. Press the function knob to start the Sabbath function.
5. Press and hold the function knob for at least 3 seconds to exit the function.

## Defrost by time



This function allows food to be defrosted by the microwave according to a selected period of time.

1. Place the dish into the oven cavity (see "Turn" procedure).
2. Use the function knob to select the defrost by time function as indicated by the  and  symbols.



3. Press the temperature knob to change the defrosting time.
4. Turn the knob to set the defrosting time (from 5 minute up to 99 hours).
5. Press the function knob to start defrosting.



If the selected defrost duration is more than 5 minutes then, for best results, the dish inside the oven compartment will need to be turned. See: "Turn" procedure.

6. On completion the word **Stop** will flash.



# Use

## Defrost by weight



This function defrosts foods on the basis of the type and weight of the frozen product.



For best results during defrosting the dish inside the oven will need to be turned. See: "Turn" procedure.



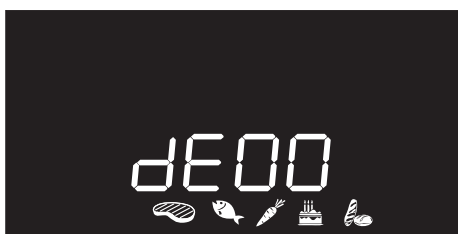

1. Place the dish into the oven cavity (see "Turn" procedure).
2. Press and rotate the function knob to select defrost by weight defrosting indicated by **dE00** and by the lit up dish symbols  .

7. At the end, **STOP** will appear and the buzzer will sound.
8. To deactivate the buzzer, press or rotate one of the two knobs or open the door.
9. Press and hold the function knob for at least 3 seconds to exit the function.



3. Press the function knob to confirm defrost by weight.
4. Turn the function knob to select the type of food to be defrosted.
5. Turn the temperature knob to select the weight (in grams) of the food to be defrosted.
6. Press the function knob to confirm the settings and start defrosting.

### Pre-set parameters

dE	Type	Weight (g)	Time (min)*
01 	Meat	500	20
02 	Fish	400	17
03 	Fruit	300	15
04 	Bread	300	5

\* Defrosting times may vary on the basis of the shape and size of the food to be defrosted.



## "Turn" procedure

For best defrosting results it is recommended, when necessary, to turn the dish inside the oven cavity.

1. Put the dish in the oven, placing it parallel to the door.

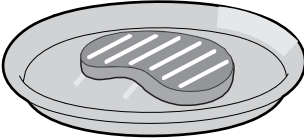

2. When **turn** is displayed it is necessary to turn the dish.

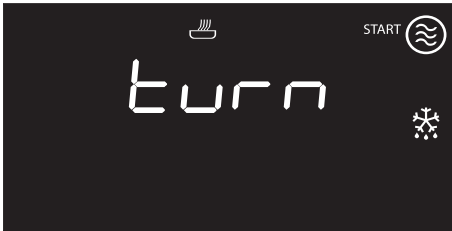

3. Open the door and turn the dish 90°.

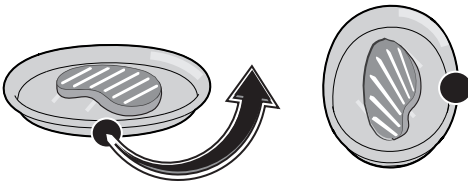

- i** If dish rotation is not performed the appliance will wait for one minute and then automatically continue defrosting. As a reminder, **turn** will remain displayed beneath the countdown indication.

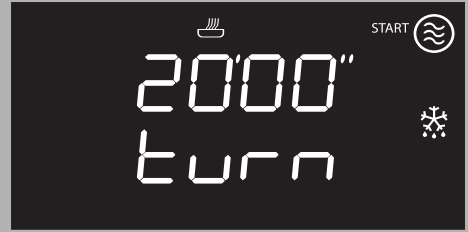

4. Close the door and press the function knob to resume operation.
5. If necessary the appliance will again ask for rotation of the dish. **turn** will appear on the display.
6. For the second rotation the door will need to be opened and the dish turned by 180°.

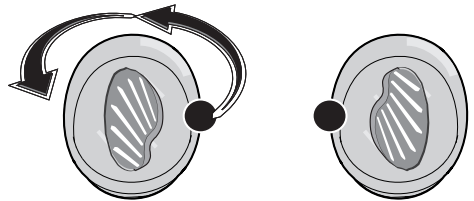

7. Close the door and press the function knob to resume operation.



## 3.6 Automatic programs

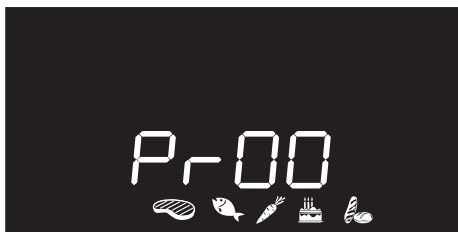

The automatic cooking programs are divided up according to the type of dish to be cooked.

1. Press and turn the function knob to select cooking with automatic programs, marked by **P-00** and the illuminated food symbols



2. Press the function knob to confirm cooking with automatic programs.
3. Turn the function knob to select the preferred program (see Automatic programs table).
4. Turn the temperature knob to select the weight (in grams) of the food to cook.

5. When preheating has finished, **START** will flash. Introduce the food and then press the function knob to start cooking.
6. At the end, **STOP** will appear and the buzzer will sound.
7. To deactivate the buzzer, press or rotate one of the two knobs or open the door.
8. Press and hold the function knob for at least 3 seconds to exit the function.



It is possible to set programmed cooking in automatic programs.







A function can be interrupted at any time by pressing and holding the function knob for at least 3 seconds.



## Automatic programs table

EN

 MEAT (01 - 05)

Pr	Subcategory	Weight (g)	Level	Function	Temperature (°C)	Time (minutes)
01	Roast beef (medium)	1000	1		200	60
02	Roast pork	1000	1		190+300W	60
03	Lamb (well done)	1200	1		190+300W	60
04	Veal (roasted)	1000	1		190+300W	70
05	Roast chicken (whole)	1000	1		200+300W	50

 FISH (06 - 07)

Pr	Subcategory	Weight (g)	Level	Function	Temperature (°C)	Time (minutes)
06	Fresh (whole)	500	1		160+300W	30
07	Frozen	500	1		160+300W	40

 VEGETABLES (08 - 10)

Pr	Subcategory	Weight (g)	Level	Function	Temperature (°C)	Time (minutes)
08	Mixed grilled	500	3		250	15 + 10 <sup>(1)</sup>
09	Roasted	1000	2		220+300W	30
10	Oven chips (frozen)	500	2		220	13

<sup>(1)</sup> When grilling, it is recommended to cook foods on both sides, making reference to the times given in the table. The greater time always refers to the first side to be cooked, starting with raw foodstuffs.



## Use



### DESSERTS/PASTRIES (11 - 13)

Pr	Subcategory	Weight (g)	Level	Function	Temperature (°C)	Time (minutes)
11	Biscuits	600	1		160	18
12	Tart	800	1		170	40



### BREAD - PIZZA - PASTA (14 -20)

Pr	Subcategory	Weight (g)	Level	Function	Temperature (°C)	Time (minutes)
13	Leavened bread (loaf)	1000	1		200	30
15	Pan baked pizza	1000	1		250	9
15	Pizza (frozen)	300	1		250	8
16	Pasta bake	2000	1		220	40
17	Lasagne (fresh)	2000	1		230	35
18	Lasagne (frozen)	300	1	+	230+500W	9
19	Quiche Lorraine	1000	1		200	40
20	Soufflé	500	1		180	25

<sup>(2)</sup> (Models without pizza stone) The stone must be positioned on the base of the oven. Frozen pizza cooked on the stone does not require different cooking times depending on weight.



The times indicated in the tables do not include preheating times and refer to cooking whole pieces. If the foodstuffs are cut into smaller portions, the cooking times will decrease.



### 3.7 Secondary menu

The appliance also has a drop-down secondary menu allowing the user to:

- Activate or deactivate the Child lock.
- Activate or deactivate Showroom mode (which disables all the heating elements so that only the control panel works).
- Activate or deactivate Low power mode (Eco-Logic).
- Activate or deactivate timed light mode (Eco-Light).

With the appliance in Stand-By mode

1. Activate the internal light by turning the temperature knob quickly.
2. Press and hold the temperature knob down for at least 5 seconds.
3. Turn the temperature knob right or left to change the setting status (**ON/OFF**).
4. Press the temperature knob to move to the next mode.

### Child lock mode

This mode allows the appliance to lock the controls automatically after one minute of normal operation without any intervention from the user.

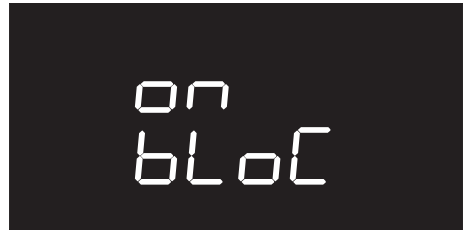
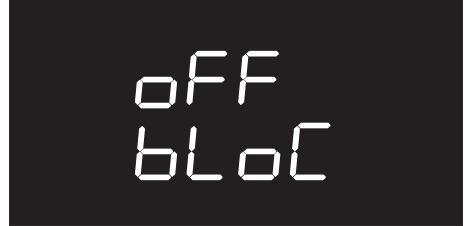

During normal operation it is indicated by the indicator light  coming on.

To release the lock temporarily during cooking, hold the temperature knob down for 5 seconds. One minute after the last setting the lock will become active again.



Varying the position of the knobs will make the display show

**bLoC** for a few seconds.



Even with the child lock mode activated the appliance can be turned off instantly by pressing the function knob for 3 seconds.



## Use

### Showroom mode (for exhibitors only)

This mode allows the appliance to deactivate all heating elements, while keeping the control panel active.



To use the appliance normally, set this mode to OFF.



If the mode is active, the  indicator light lights up on the display.

### Low power mode

This mode allows the appliance to limit the power used.

Suitable for simultaneous use with further home appliances.

HI: normal power.



LO: low power.



Activating low power mode means that preheating and cooking times may be extended.



If the mode is active, the  indicator light lights up on the display.





### Keep Warm Mode (some models only)

In this mode, at the conclusion of the cooking cycle for which a duration was set (if not stopped manually), the appliance keeps freshly cooked food warm (at low temperatures) for around 1 hour.



### Timed light mode

For energy saving the internal light is switched off automatically one minute after cooking begins.



To prevent the appliance from automatically turning the internal light off turn this mode to OFF.



With both settings the manual on/off control is always available by turning the temperature knob to the right.



# Cleaning and maintenance

## 4 Cleaning and maintenance

### Instructions



**High temperature inside the oven during use**

#### **Danger of burns**

- Perform cleaning only after letting the appliance cool down.



**Improper use**

#### **Risk of damage to surfaces**

- Do not use steam jets to clean the appliance.
- Do not use cleaning products containing chlorine, ammonia or bleach on parts made of steel or that have metallic surface finishes (e.g. anodizing, nickel- or chromium-plating).
- Do not use abrasive or corrosive detergents (e.g. scouring powders, stain removers and metallic sponges) on glass parts.
- Do not use rough or abrasive materials or sharp metal scrapers.
- Failure to clean the oven could adversely affect the life of the appliance and pose a hazard.
- Always remove food residues from the oven cavity.



**Improper use**

#### **Danger of explosion/burns**

- Do not use detergents with high alcohol content or which can release inflammable vapours. Subsequent heating could set off an explosion inside the appliance.



If a lamp is damaged, contact Technical support for a replacement. This fault will not affect the integrity of the appliance which can continue to be used.

### 4.1 Cleaning the surfaces

To keep the surfaces in good condition, they should be cleaned regularly after use. Let them cool first.

#### **Ordinary daily cleaning**

Always use only specific products that do not contain abrasives or chlorine-based acids.

Pour the product onto a damp cloth and wipe the surface, rinse thoroughly and dry with a soft cloth or a microfibre cloth.



## Food stains or residues

Do not use steel sponges and sharp scrapers, as they will damage the surfaces.

Use ordinary non-abrasive products with the aid of wooden or plastic utensils if necessary. Rinse thoroughly and dry with a soft cloth or a microfibre cloth.

Do not allow residues of sugary foods (such as jam) to set inside the oven. If left to set for too long, they might damage the enamel lining of the oven.

## 4.2 Cleaning the door glazing

The glass in the door should always be kept thoroughly clean. Use absorbent kitchen roll. In case of stubborn dirt, wash with a damp sponge and an ordinary detergent.



We recommend the use of cleaning products distributed by the manufacturer.

## 4.3 Cleaning the oven

For the best oven upkeep, clean it regularly after having allowed it to cool.

Do not allow residues of foods to set inside the oven, as these could damage the enamel lining of the oven.

Before cleaning, take out all removable parts.

For easier cleaning, it is recommended to remove the rack/tray support frames.



When using specific cleaning products, the appliance should be operated at the maximum temperature for about 15-20 minutes, to burn off any residues.

## Drying

Cooking food generates moisture inside the appliance. This is a normal phenomenon and does not affect the appliance's operation in any way.

Each time you finish cooking:

1. Let the appliance cool down.
2. Remove any dirt from inside the appliance.
3. Dry the interior of the appliance with a soft cloth.
4. Leave the door open until the inside of the appliance has dried completely.



## Cleaning and maintenance

### Removing rack/tray support frames

Removing the guide frames enables the sides to be cleaned more easily.

To remove the guide frames:

1. Unscrew the frame fastening pins:

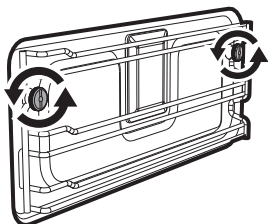

2. Pull the frame toward the inside of the cavity to release it from the fastening pins.

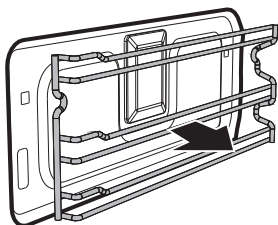

3. When cleaning is complete, repeat the above procedures to put the guide frames back in. Pay attention to the spacer bushings which need to be inserted correctly into the frames.

### Cleaning the top section



**High temperature inside the oven during use**

**Danger of burns**

- The following operations must only be carried out when the oven is completely cold and switched off.

The appliance is equipped with a tilting grill element that allows for easy cleaning of the upper part of the oven cavity.

1. Free the upper heating element by gently lifting it and rotating its retaining latch by 90 degrees.

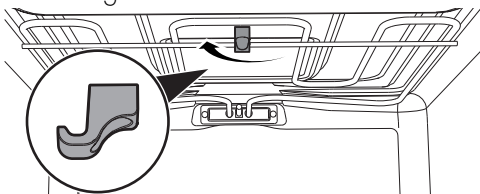

2. Gently lower the heating element until it stops.

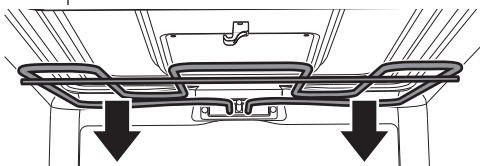

**Improper use**

**Risk of damage to the appliance**

- Do not excessively flex the element during cleaning.

3. When you have finished cleaning, place the heating element back in position and turn the retaining latch to lock it in place.



## 4.4 Vapor Clean



Vapor Clean is an assisted cleaning procedure which facilitates the removal of dirt. Thanks to this process, it is possible to clean the inside of the oven very easily. The dirt residues are softened by the heat and steam, making them easier to remove afterwards.



### Improper use Risk of damage to surfaces

- Remove any large amounts of food residues or spills from previous cooking operations from the inside of the oven.
- Carry out assisted oven cleaning operations only when the oven is cold.

### Preliminary operations

Before starting the Vapor Clean function:

- Completely remove all accessories from inside the oven. The upper guard can be left inside the oven.

- Pour approx. 40 cc of water onto the floor of the oven. Make sure it does not overflow out of the cavity.

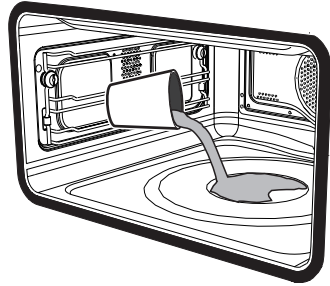

- Spray a water and washing up liquid solution inside the oven using a spray nozzle. Direct the spray against the side walls, upwards, downwards and towards the deflector.

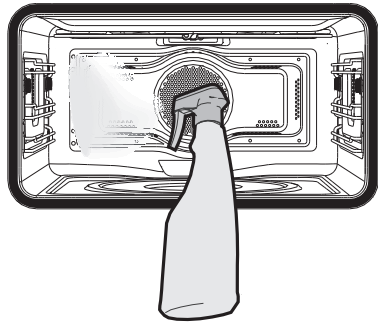

We recommend spraying approx. 20 times at the most.

- Close the door.



## Cleaning and maintenance

### Vapor Clean setting

**i** If the internal temperature is greater than that required for the Vapor Clean cycle, the cycle will be stopped immediately and the message **Stop** will appear on the display. Let the appliance cool down before activating the assisted cleaning cycle.

1. Press and turn the function knob to select the Vapor Clean function . The duration and temperature of the cleaning cycle will appear on the display.

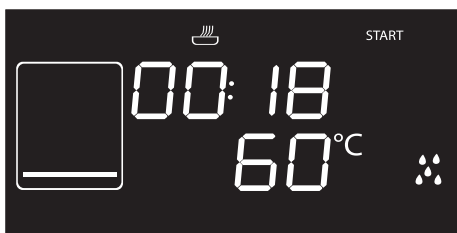

**i** The temperature and time parameters cannot be modified by the user.

2. Press the function knob to start the automatic cleaning cycle.

### Programmed Vapor Clean cycle

Like for the normal cooking functions, it is also possible to set an end time for the Vapor Clean function.

1. After selecting the Vapor Clean function, press the temperature knob. The  indicator light will start flashing. The display shows the function end time.

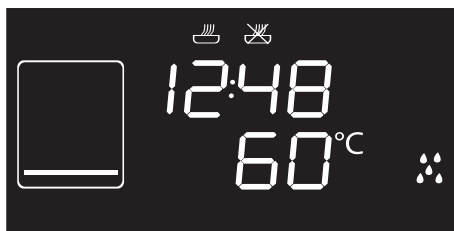

2. Turn the temperature knob right or left to delay the cooking end time.
3. Press the temperature knob to confirm the function end time.
4. Press the function knob. The appliance waits for the set start time.

### End of the Vapor Clean cycle

At the end **Stop** appears on the display and a buzzer will sound that can be deactivated by pressing the temperature knob.

1. Press and hold the function knob for at least 3 seconds to exit the function.
2. Open the door and wipe away the less stubborn dirt with a microfibre cloth.



3. Use an anti-scratch sponge with brass filaments on tougher encrustations.
4. In case of grease residues use specific oven cleaning products.
5. Remove any remaining water from the oven.

For greater hygiene and to avoid food being affected by any unpleasant odours, we recommend that the oven is dried using a fan-assisted function at 160°C for approximately 10 minutes.



We recommend wearing rubber gloves for these operations.



For easier manual cleaning of parts that are difficult to reach, we recommend removing the door.

## What to do if...

The display is completely off:

- Check the mains power supply.
- Check whether an all-pole circuit breaker upline of the appliance power supply line is in the "ON" position.

The appliance does not heat up:

- Check whether it has been set in "showroom" mode (for further details see 3.7 Secondary menu).

The controls do not respond:

- Check whether it has been set in "child lock" mode (for further details see "Secondary menu").

The cooking times are longer than those indicated in the table:

Check whether it has been set in "low power" mode (for further details see "Secondary menu").

If the door is opened during a fan assisted function, the fan stops:

- This is not a fault. It is a normal operation of the appliance, useful when cooking foods in order to avoid excessive heat escaping. When the door is closed, the oven will return to normal operation.



If the problem has not been resolved or in the case of other types of fault, contact your local technical support centre.



If other ERRx error messages are indicated:

Note down the error message, function and set temperature and contact your local technical support centre.



# Installation

## 5 Installation

### 5.1 Electrical connection



**Power voltage**  
**Danger of electrocution**

- Have the electrical connection performed by authorised technical personnel.
- The appliance must be connected to earth in compliance with electrical system safety standards.
- Disconnect the mains power supply.

#### General information

Check the grid characteristics against the data indicated on the plate.

The identification plate bearing the technical data, serial number and brand name is visibly positioned on the appliance.

Do not remove this plate for any reason.

The appliance works at 220-240 V~.

Use a three-pole cable (3 x 1.5 mm<sup>2</sup> internal conductors).

Perform the ground connection using a wire that is 20 mm longer than the other wires.

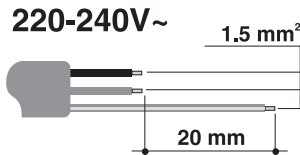

#### Fixed connection

Fit the power line with an all-pole circuit breaker in compliance with installation regulations.

The circuit breaker should be located near the appliance and in an easily reachable position.

#### Connection with plug and socket

Make sure that the plug and socket are of the same type.

Avoid using adapters, gang sockets or extensions as these could cause overheating and a risk of burns.

#### Cable replacement



**Power voltage**  
**Danger of electrocution**

- Disconnect the mains power supply.

1. Unscrew the rear casing screws and remove the casing to access the terminal board.
2. Replace the cable.
3. Make sure that the cables (for the oven or any hob) follow the best route in order to avoid any contact with the appliance.





## 5.2 Positioning



**Heavy appliance**  
**Crushing hazard**

- Position the appliance into the cabinet cutout with the help of a second person.



**Pressure on the open door**  
**Risk of damage to the appliance**

- Never use the oven door to lever the appliance into place when fitting.
- Avoid exerting too much pressure on the oven door when open.



**Heat production during appliance operation**  
**Risk of fire**

- Check that the carcass material is heat resistant.
- Check that the carcass has the required slots.
- Do not install the appliance in a recess which can be closed with a door, or in a cupboard.

## Position of the power cable

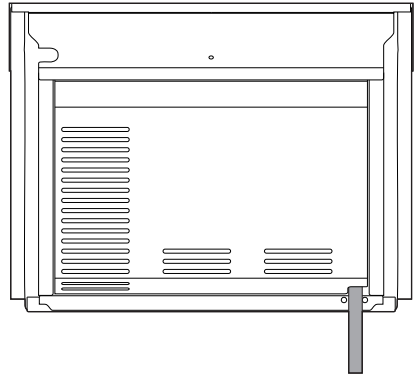

(rear view)

## Front panel seal

Glue the supplied seal to the rear part of the front panel to avoid water or other liquids from leaking in.

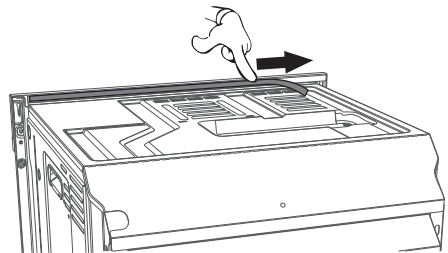



# Installation

## Fastening bushings

Remove the bushing covers inserted on the oven front.

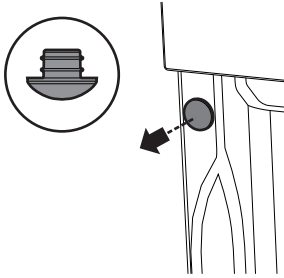

Mount the appliance into the recess.  
Secure the appliance to the piece of furniture using screws.

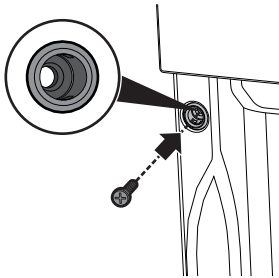

Cover the bushings with the previously removed covers.

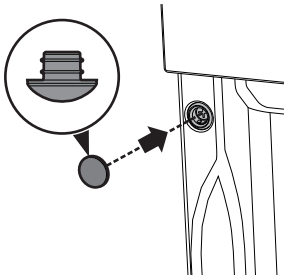

## Appliance overall dimensions (mm)

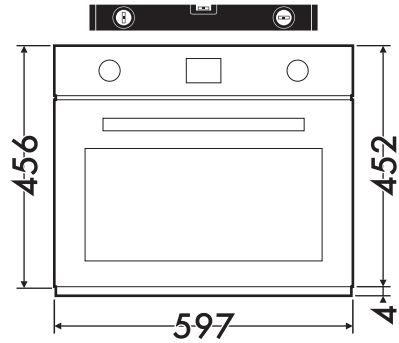

(front view)

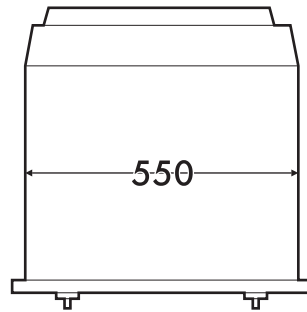

(top view)



## Mounting under worktops (mm)

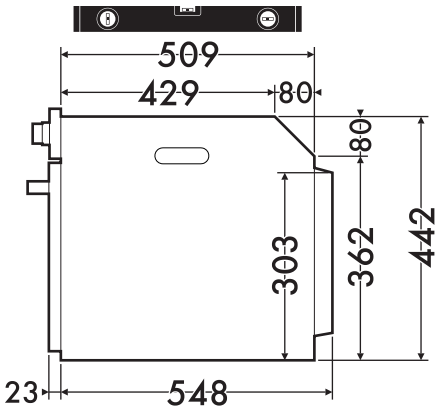

(side view)

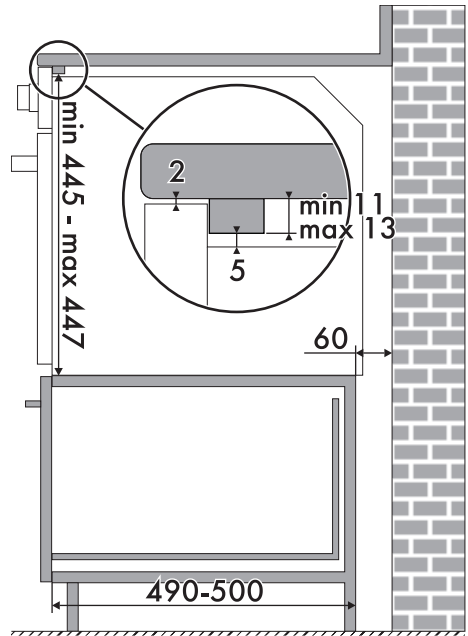
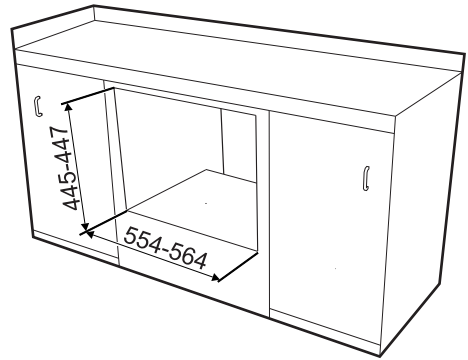
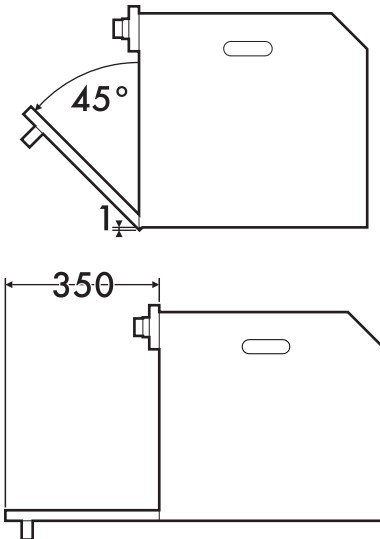

Make sure that the carcass rear / bottom section has an opening of approx. 60 mm.



# Installation

## Mounting into a column (mm)

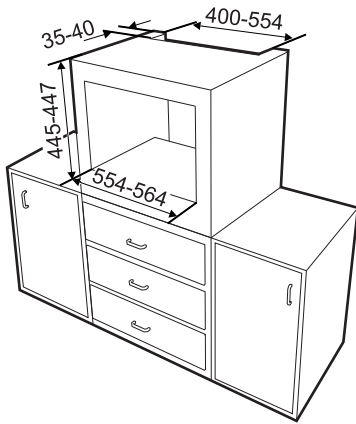

Make sure that the piece of furniture top/rear part has an opening approx. 35-40 mm deep.

